

VIMALUX

A brighter vision

Solar Street lights



5
years
warranty

NHP





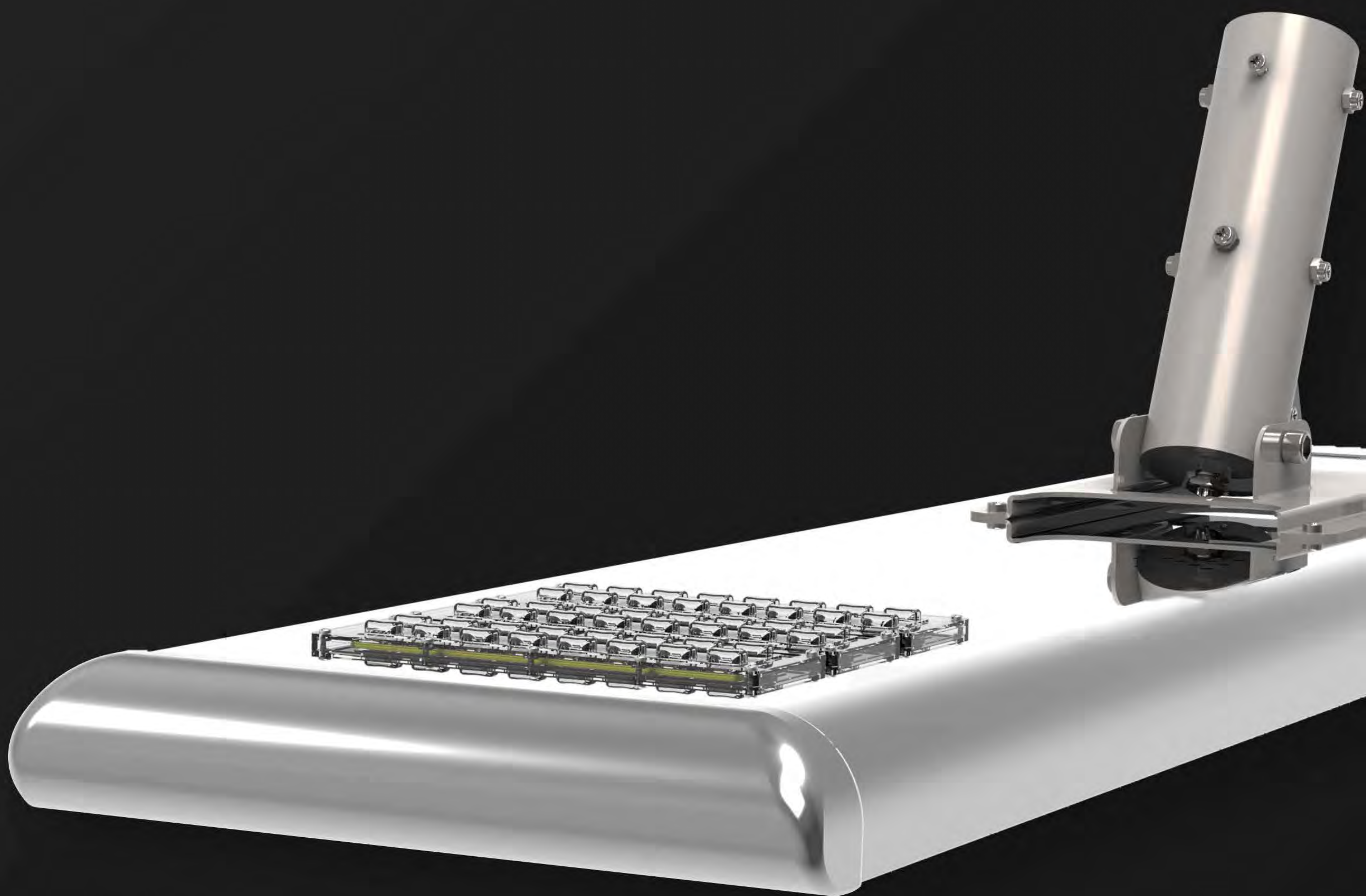

All aluminium alloy design



Easy installation
tool free buckle design



Adjustable led source(Optional)

High efficiency solar panel
(24% efficiency)

Solar Panel

Battery Pack

CATL brand ,6000 cycles
lifespan,IP67

MPPT

Smart programmable

LED

Max 5W per Chip
240LM/W

Aluminum Alloy Housing

Excellent heat dissipation
design AL6063

Bracket

Anti corrosion
Angle adjustable

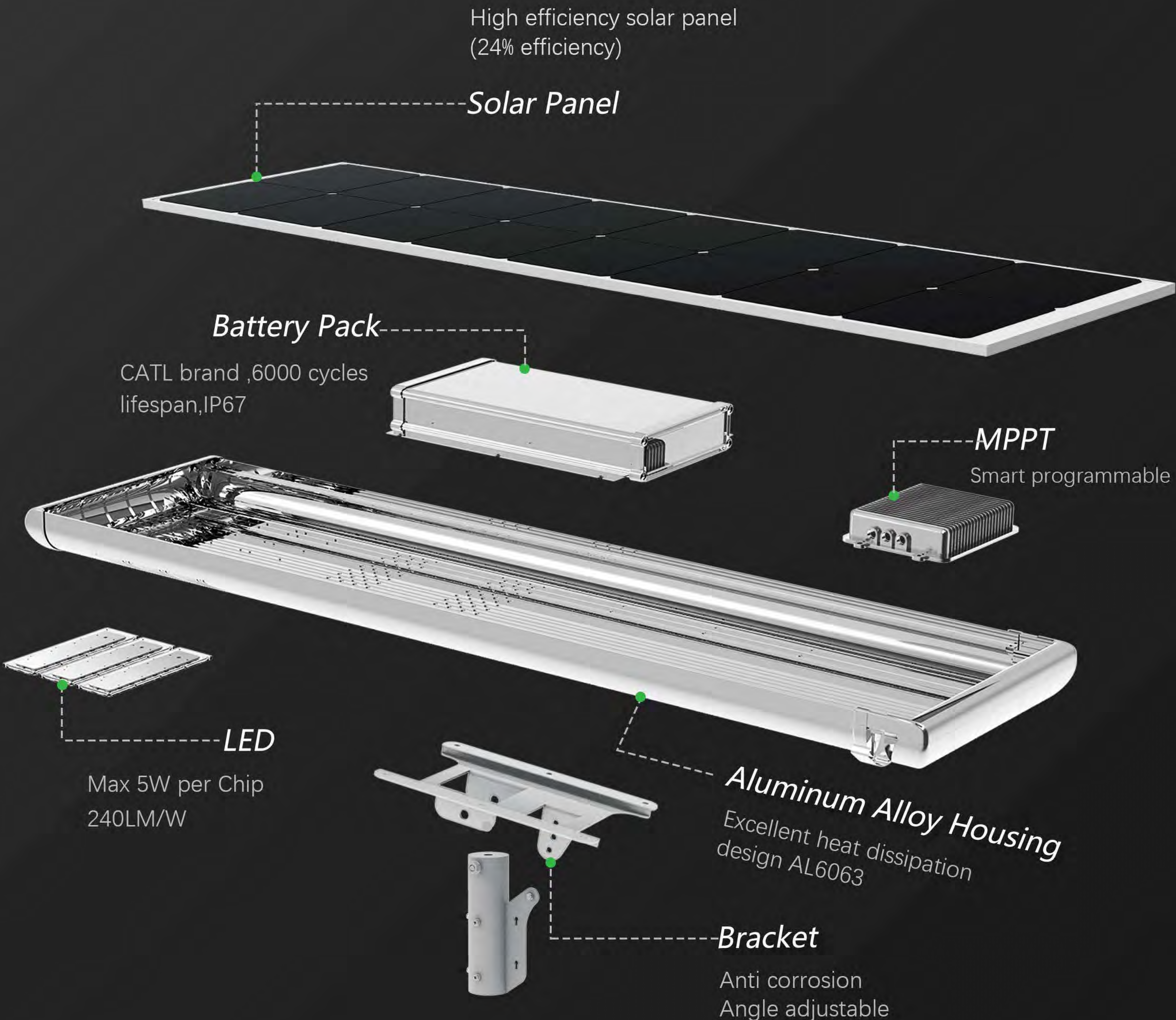



NEW HP LED module - Easily folds and unfolds, Best applied for either directions of road to let Solar panels absorb Maximum sunlight

ALSO WE HAVE WHAT OTHERS DON'T



Modular design
SKD shipping available



Buckle design, Easy installation
Tools free maintainance



New generation of solar cell
60% increase in efficiency



All aluminium alloy design



Built in four kinds of
working mode



Adjustable led source

Mode NO.	NHP-3000	NHP-5000	NHP-8000	NHP-10000
----------	----------	----------	----------	-----------

Lighting

Light Output	3000 - 5000LM	5000-10000LM	8000-15000LM	10000-25000LM
LED Chip	High bright 5050 (5W/PCS,240LM/W)			
CCT	2700-6000K (can be customized)			
Life Span	100,000 hours to LM80 specifications			
Working Way	Motion Sensor / IoT / Time Schedule			

Solar Panel

Power of PV module	40W	70W	100W	130W
Life Span	80% power after 25 years			

Storage

Battery Capacity	280WH	390WH	550WH	825WH
Lighting time in rainy day	>10 days			
Life Span	4000 Cycles (>10 years)			

Charging Controller

Life Span	>12 years
Working Mode	MPPT
Control Mode	Intelligent, activated by sunlight

Environment

Working Temperature	-15°C to +70°C
Water Resistance	IP65

Solar Panel Autoclean

—

Mechanical Specifications

Recommended Top diameter of the Pole	76mm			
Recommended Pole Height	3m-6m	6m-8m	8m-10m	10m-12m
Gross Weight (Kg)	11.5	19	24.5	30
Product Dimension (mm)	457*406*84	822*406*84	1206*406*84	1580*406*84

NHP-3000 / 5000 / 8000 / 10000

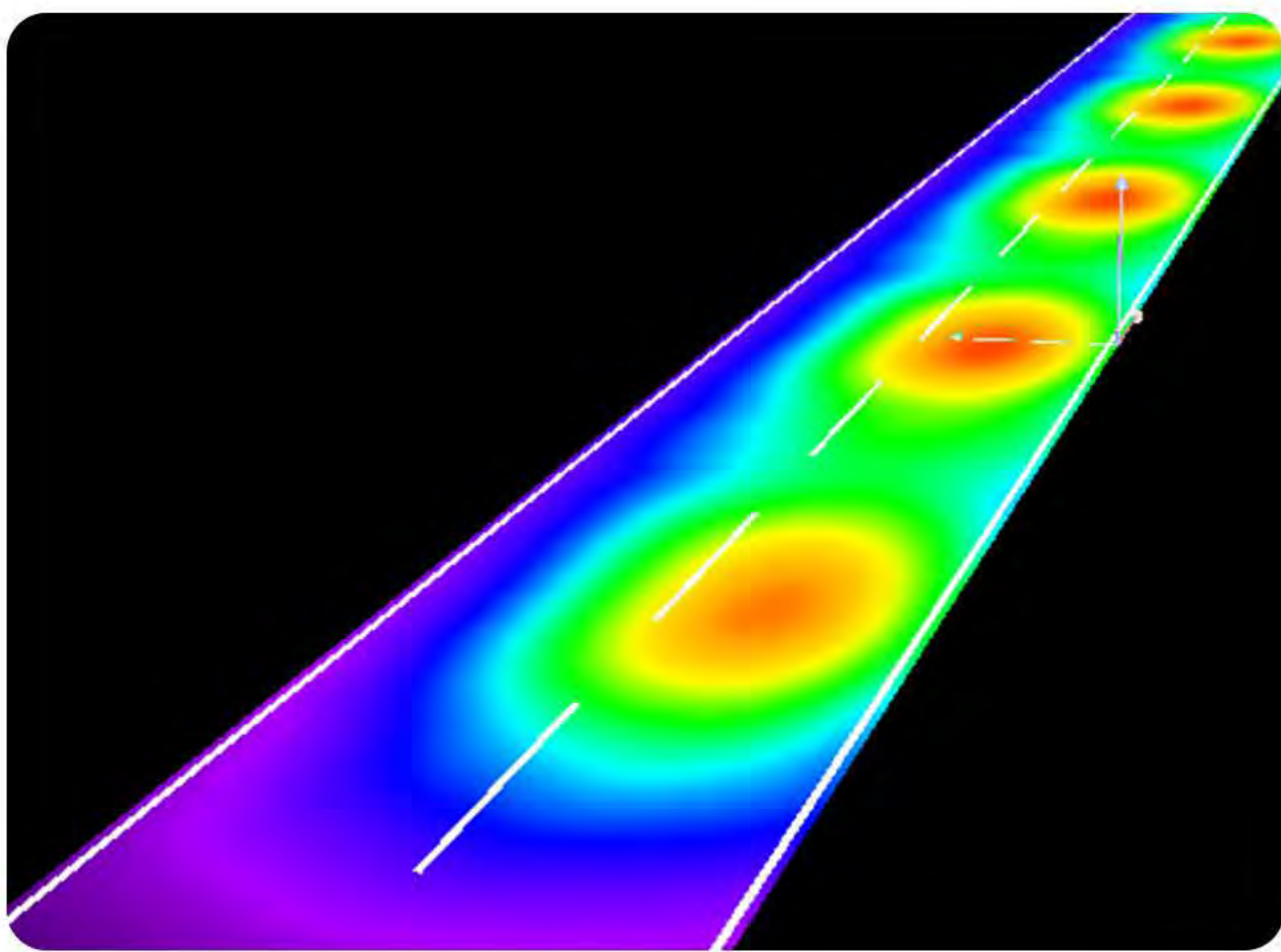
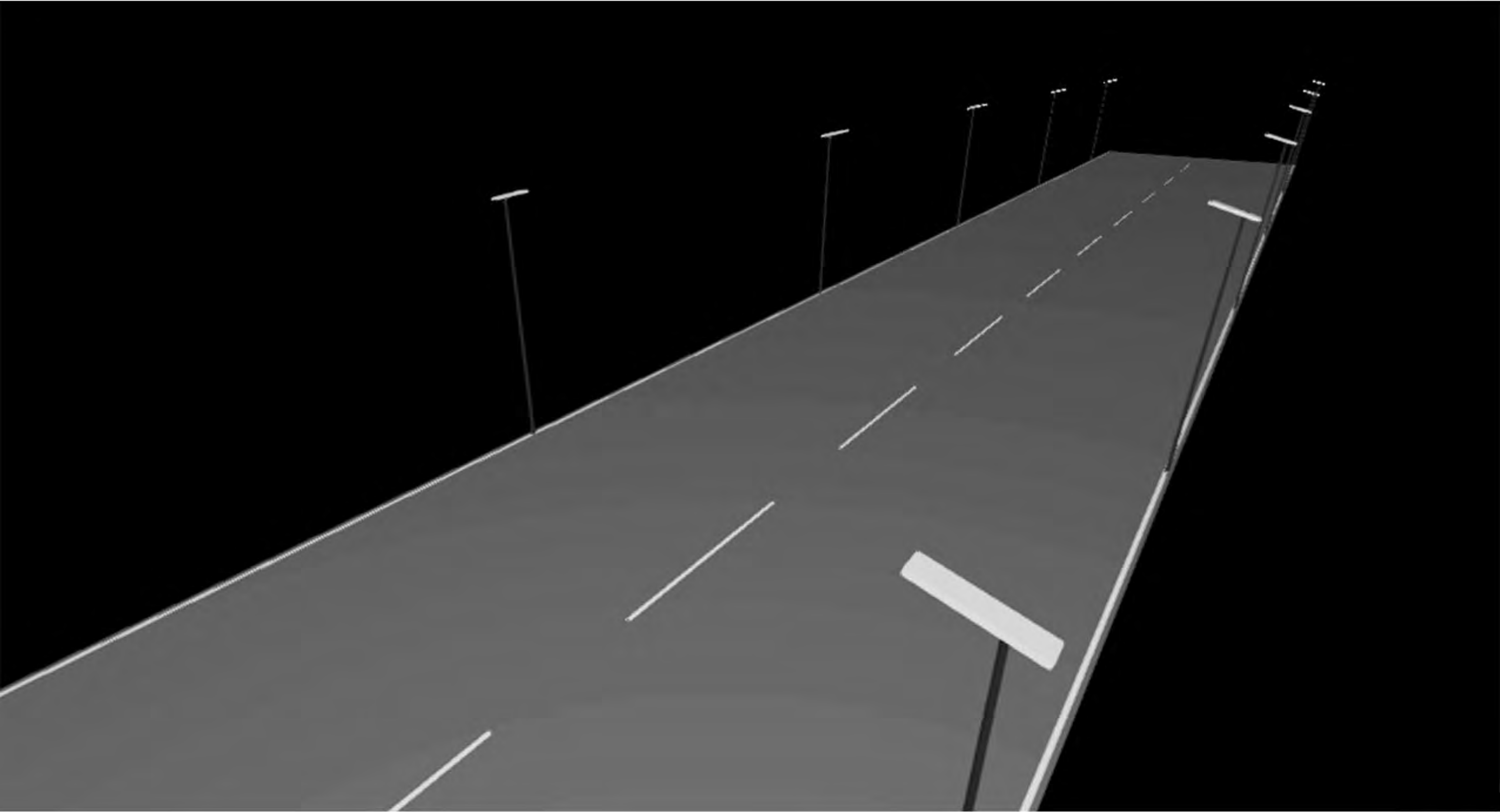

Road Simulated Diagram

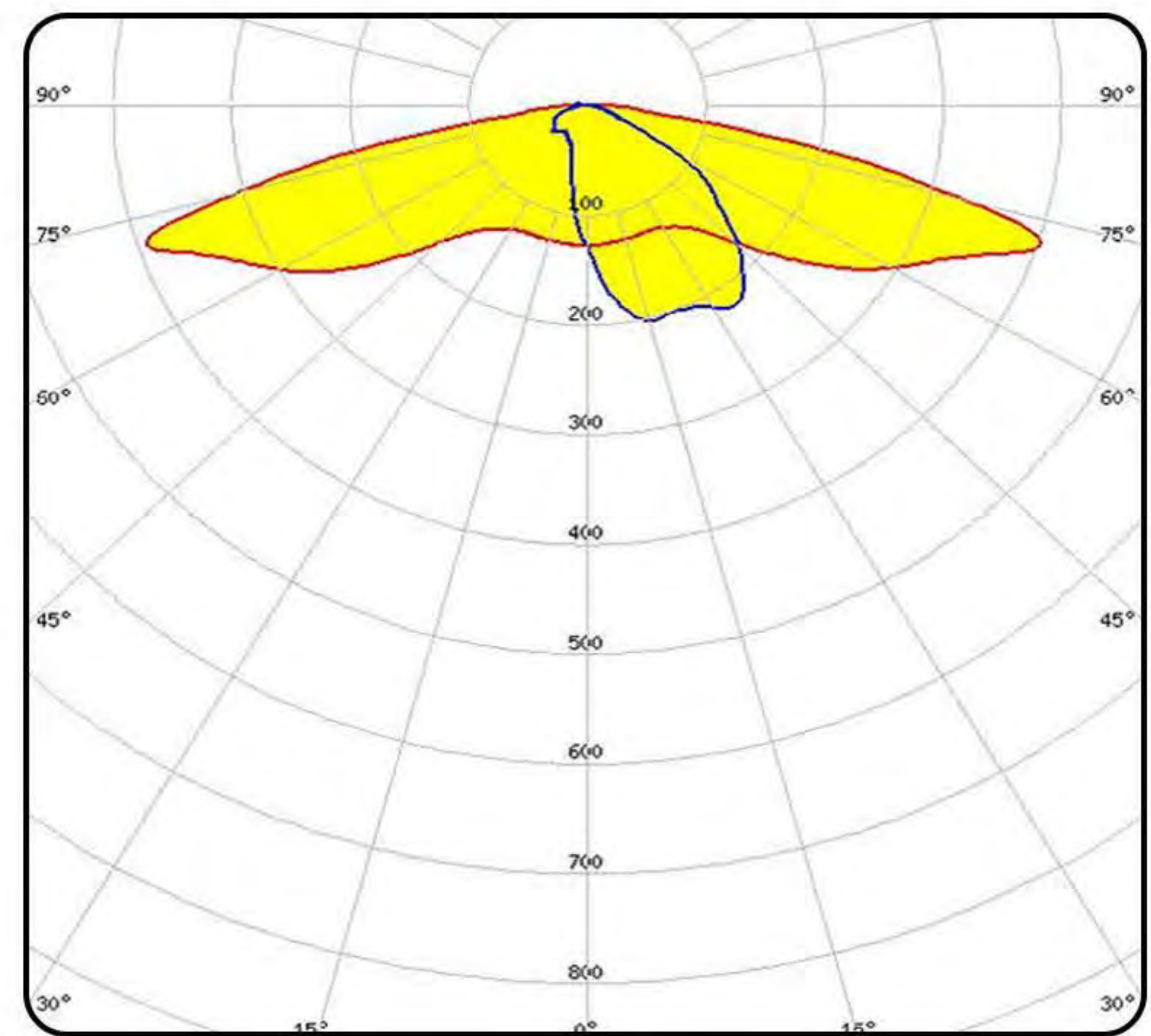

Light Distribution Curve

< 1 >

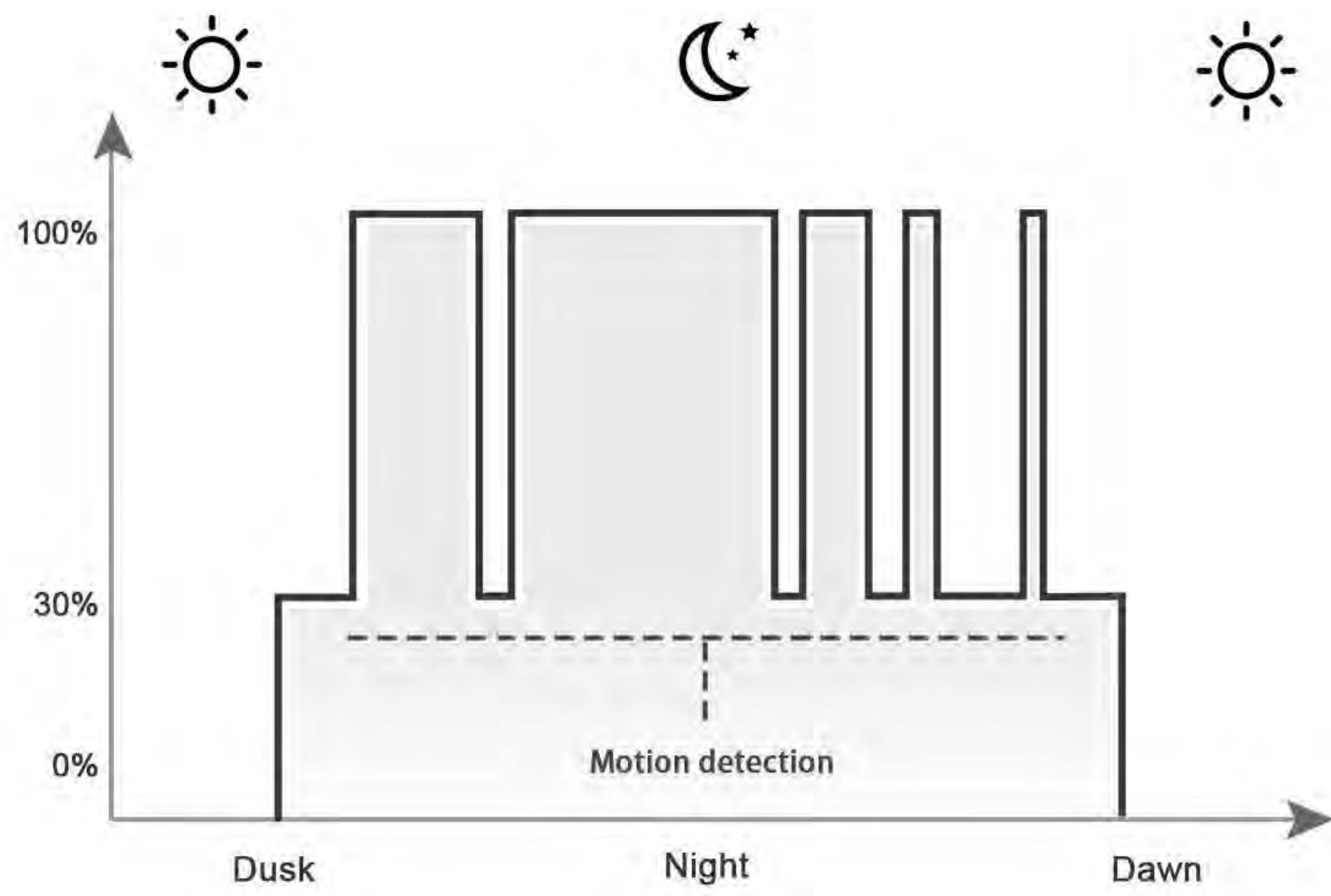

(30% brightness + motion detection till dawn)

< 2 >

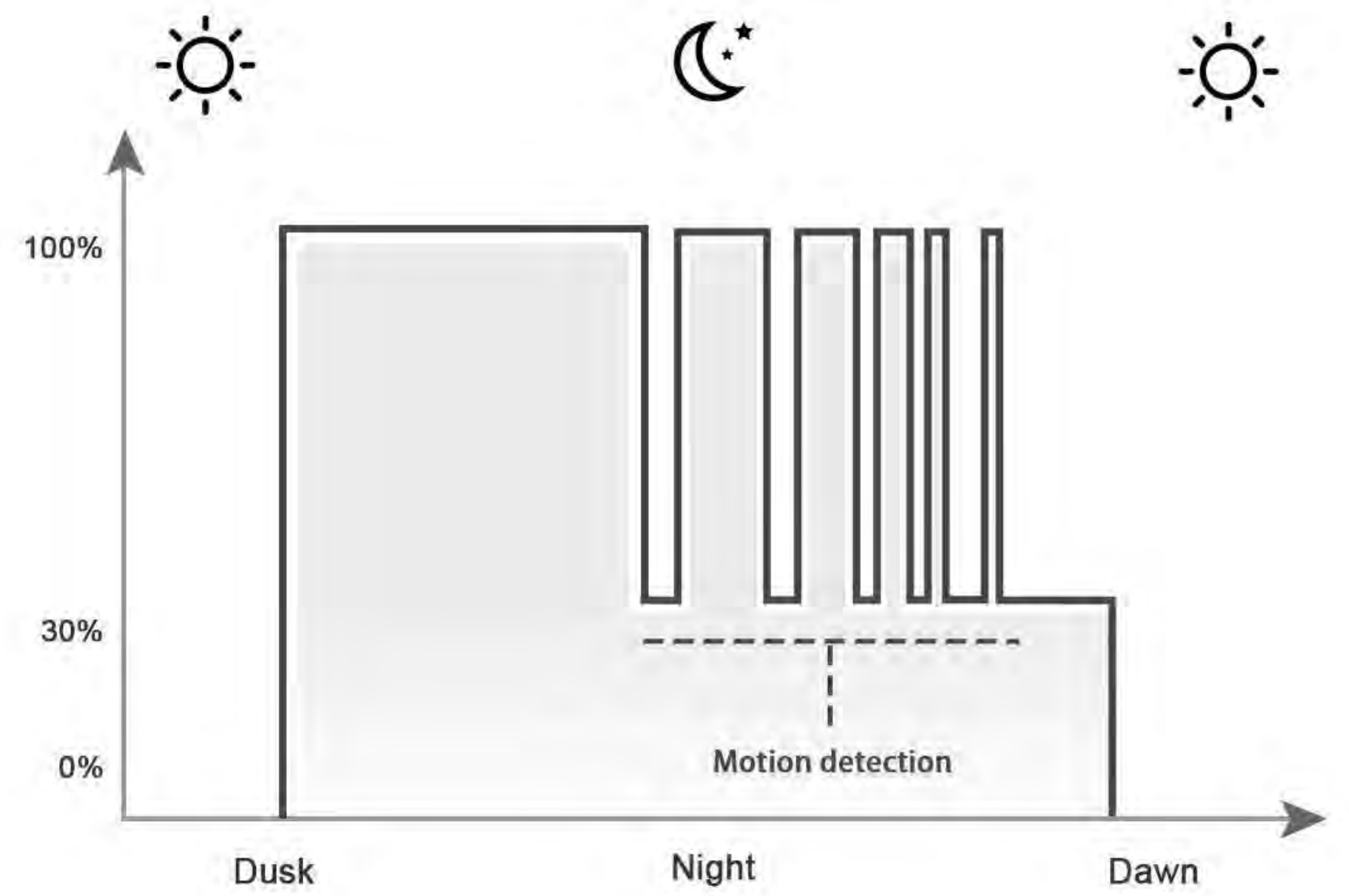

(5hours 100% brightness+30% brightness with motion detection till dawn)

< 3 >

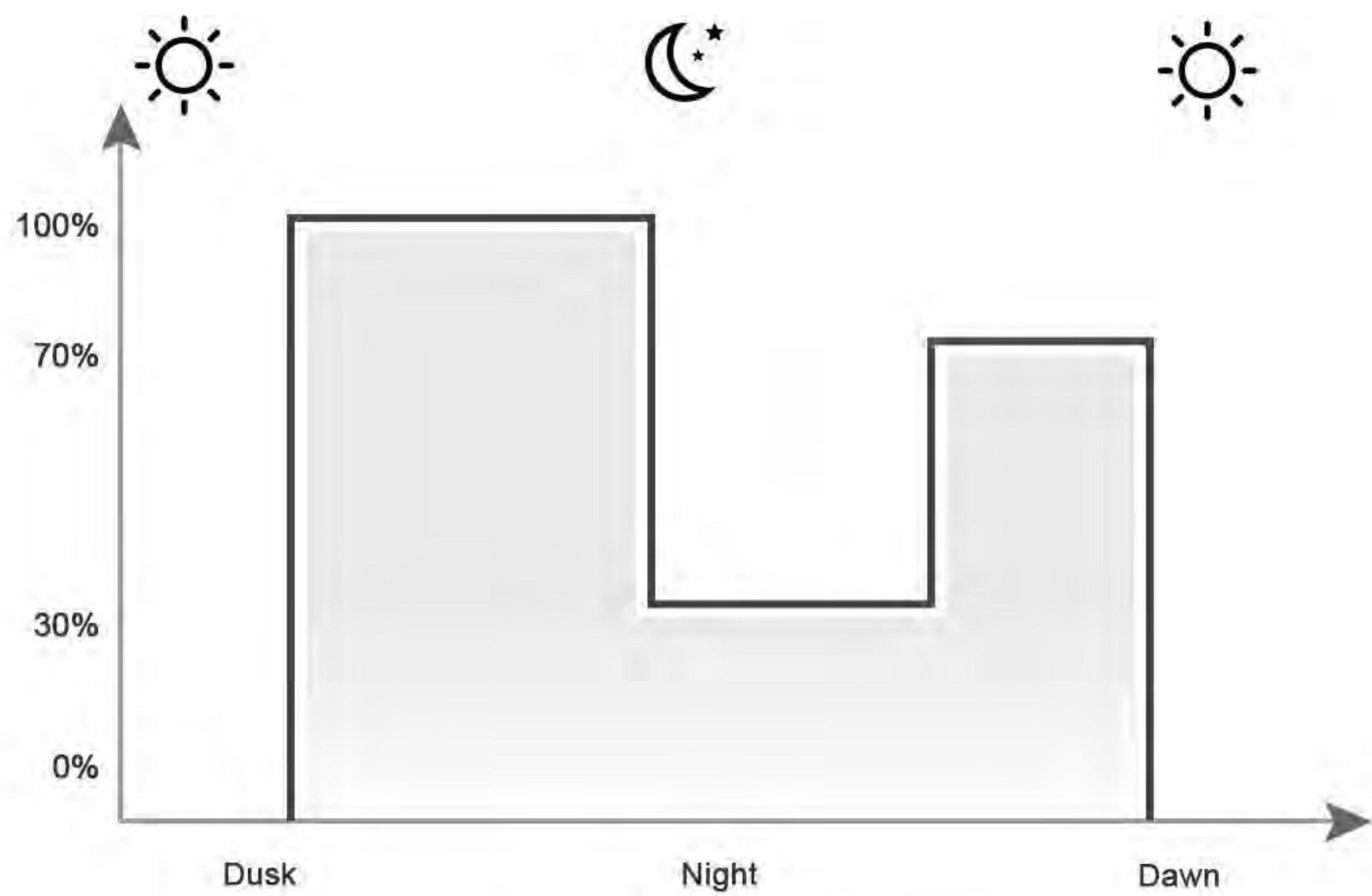

(5hours 100% brightness+4 hours 30% brightness+70% brightness till dawn)

< 4 >

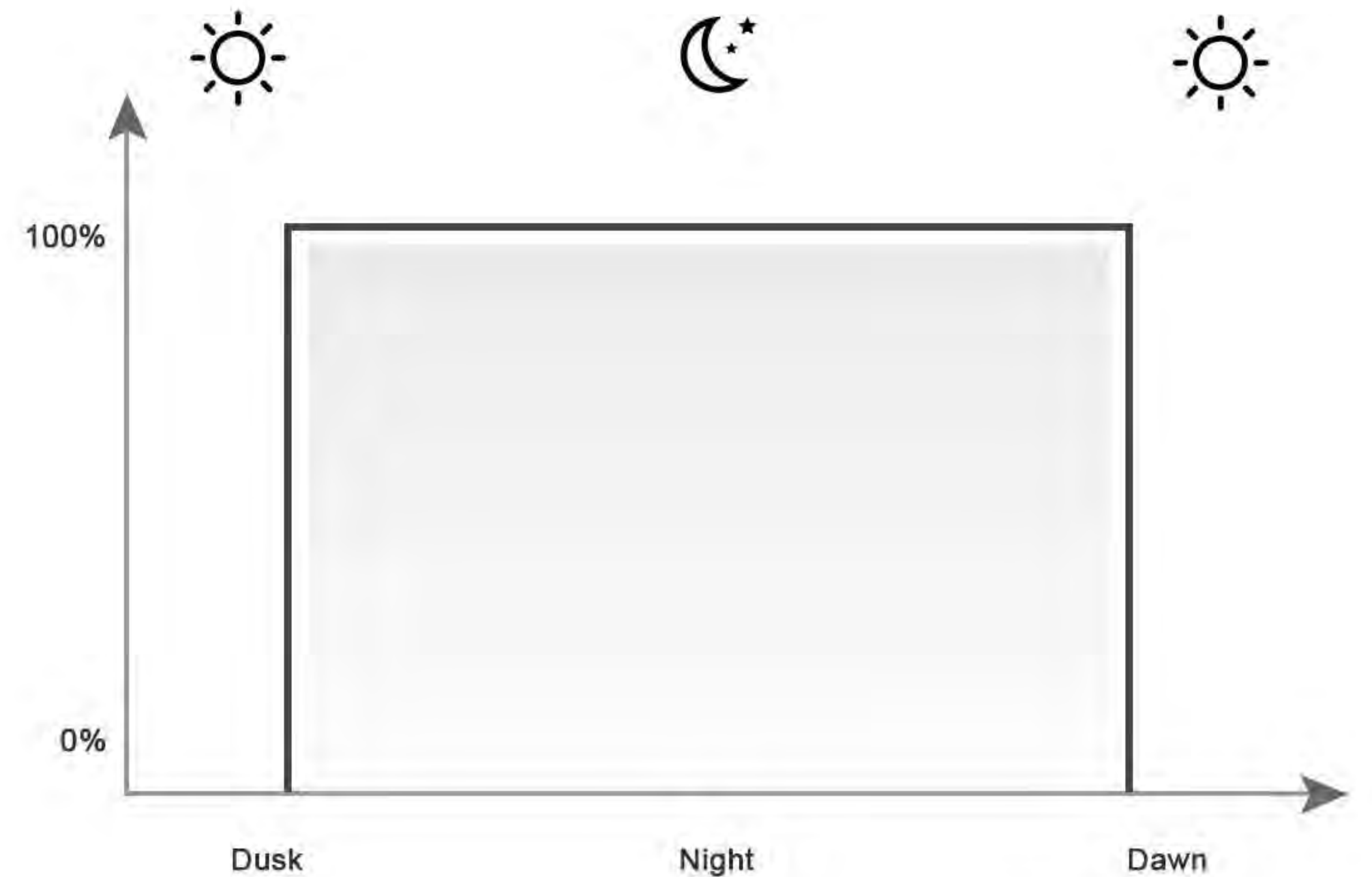

(100% brightness till dawn)

NHP | FIGURE DIMENSION

NHP-3000

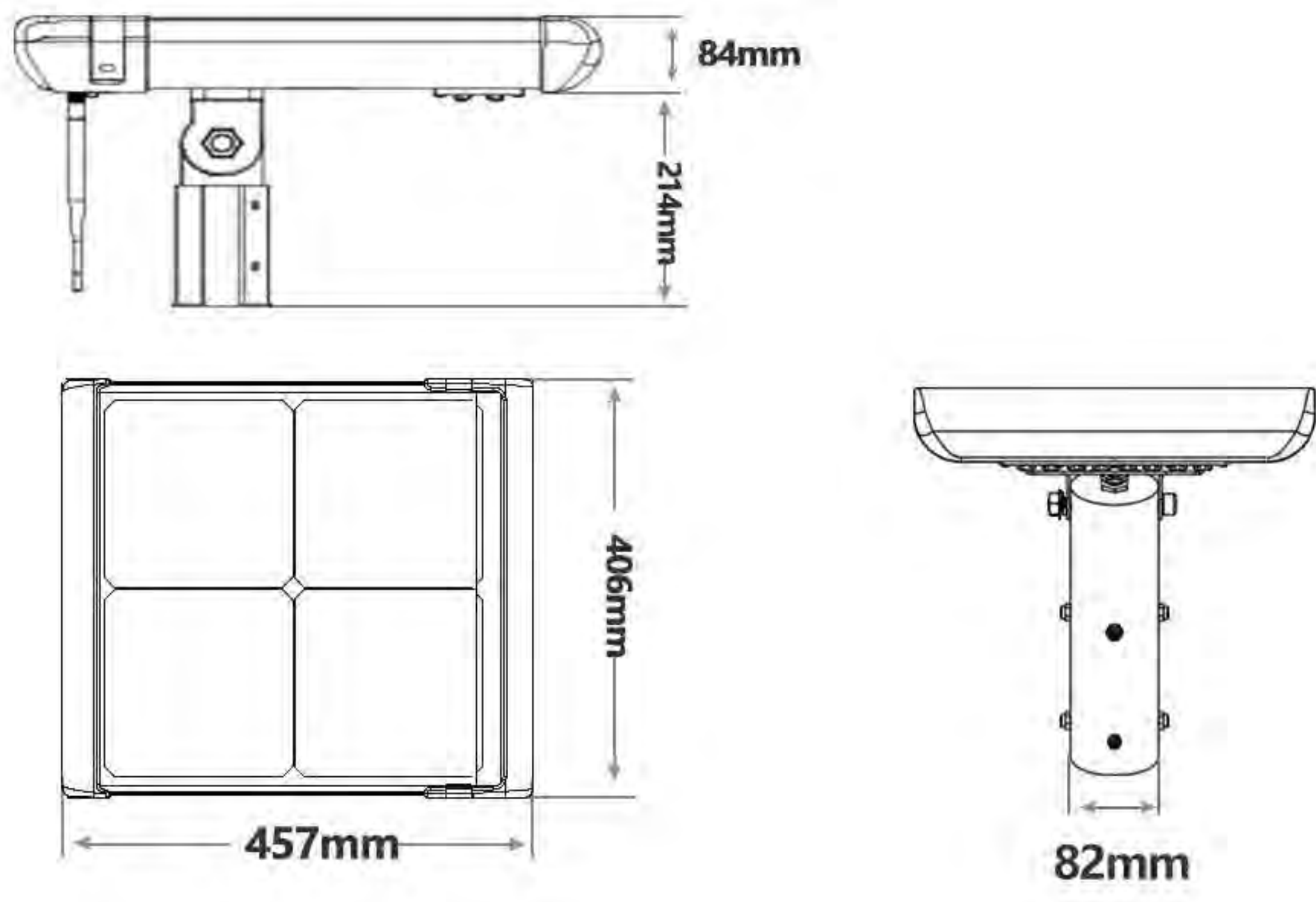

NHP-5000

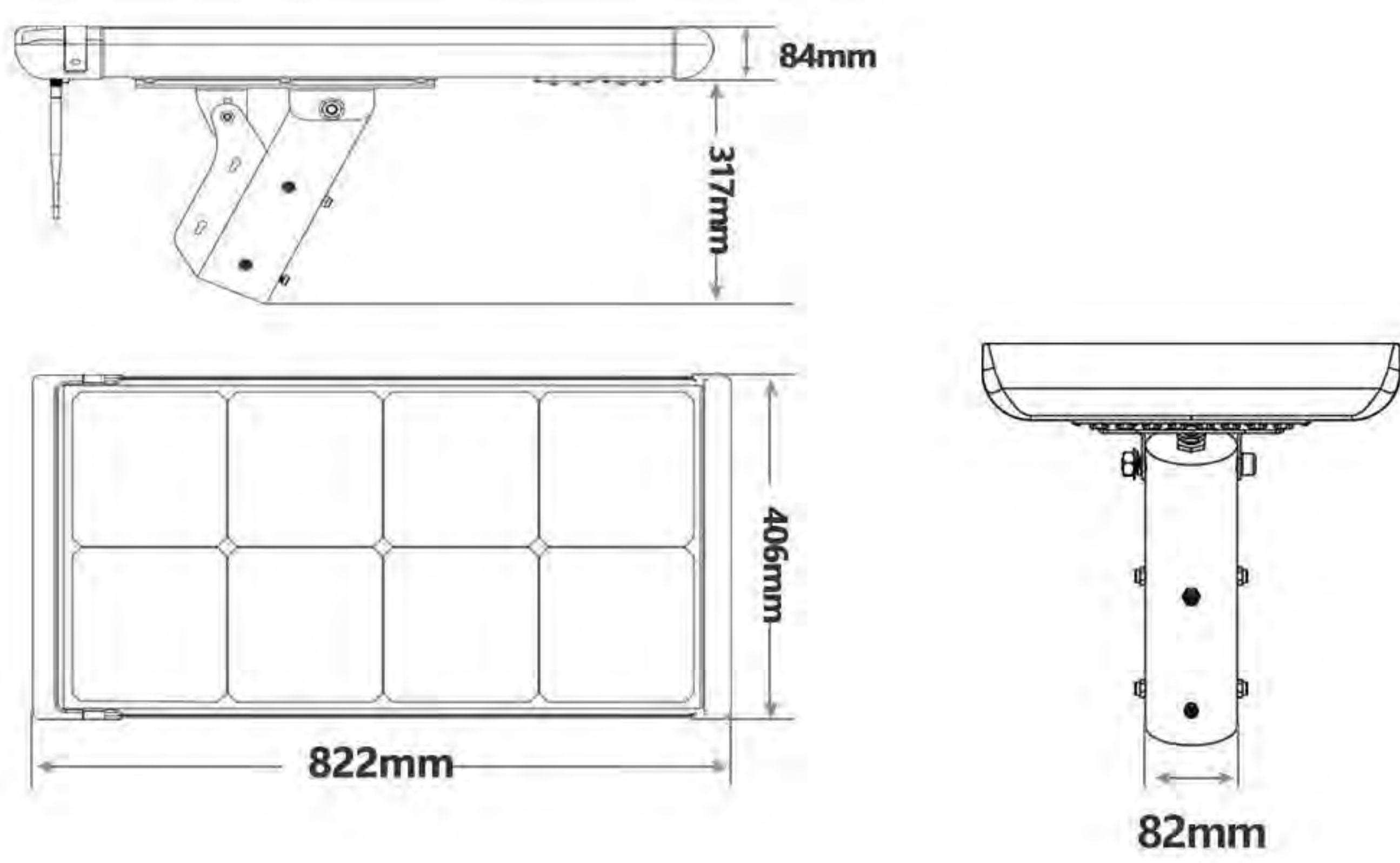

NHP-8000

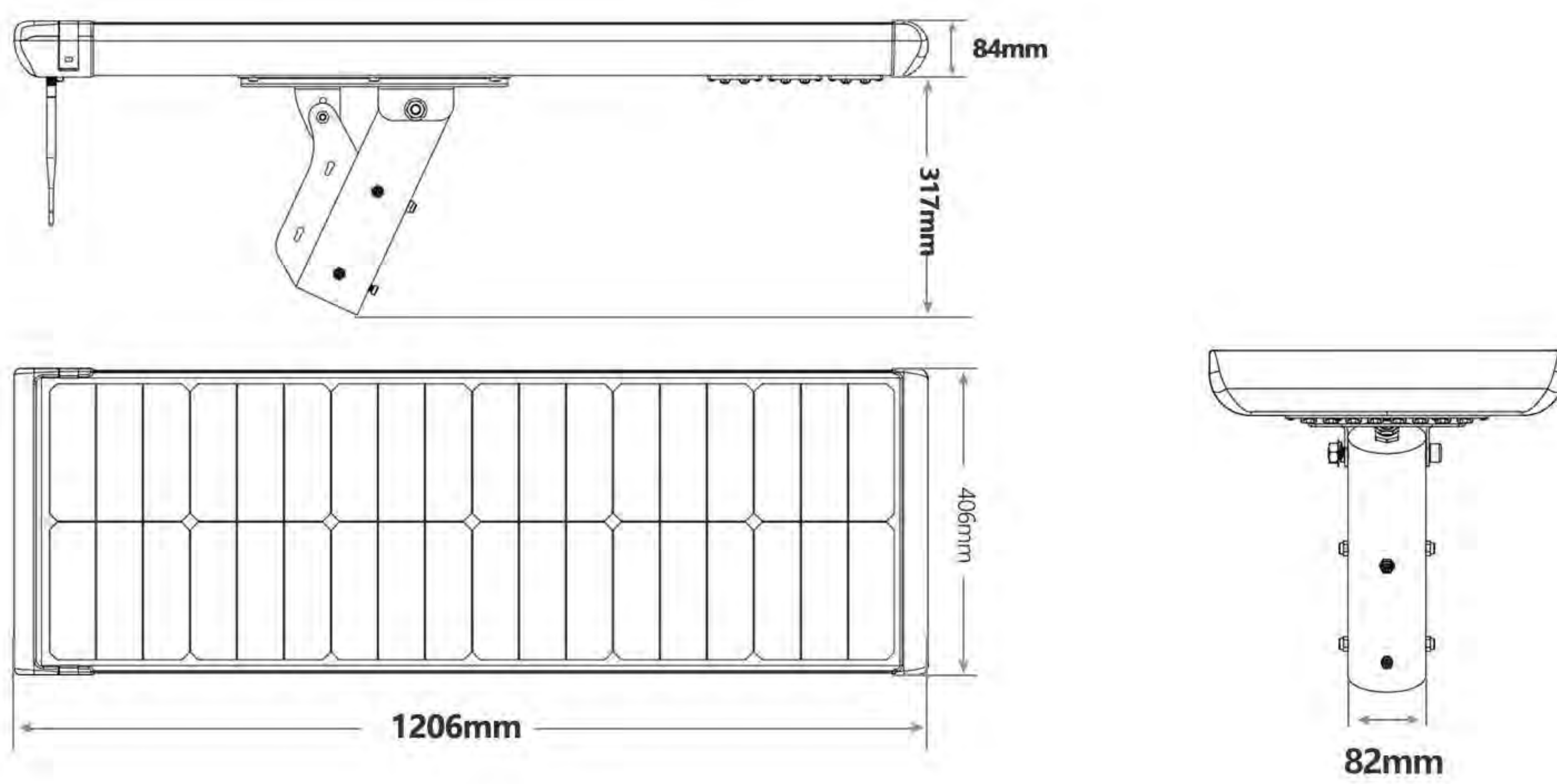

NHP-10000

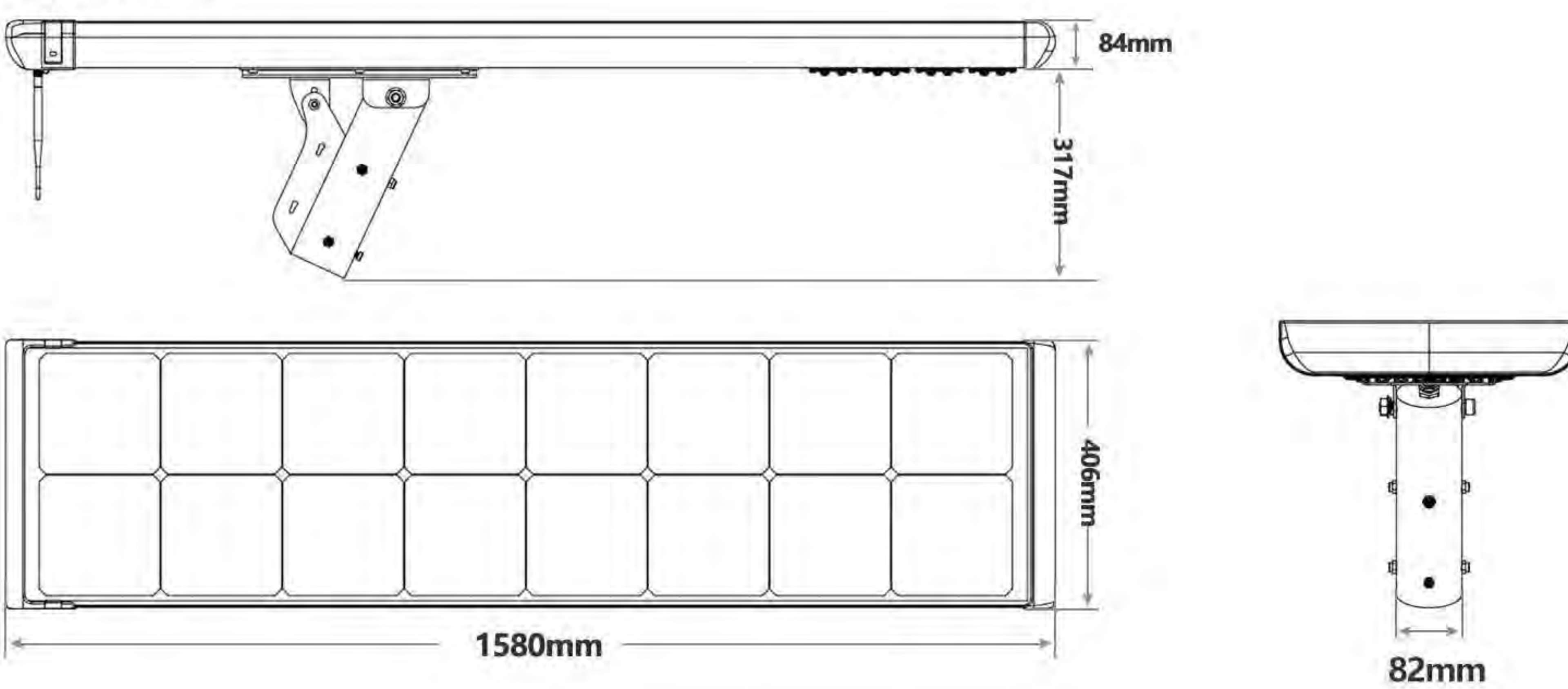

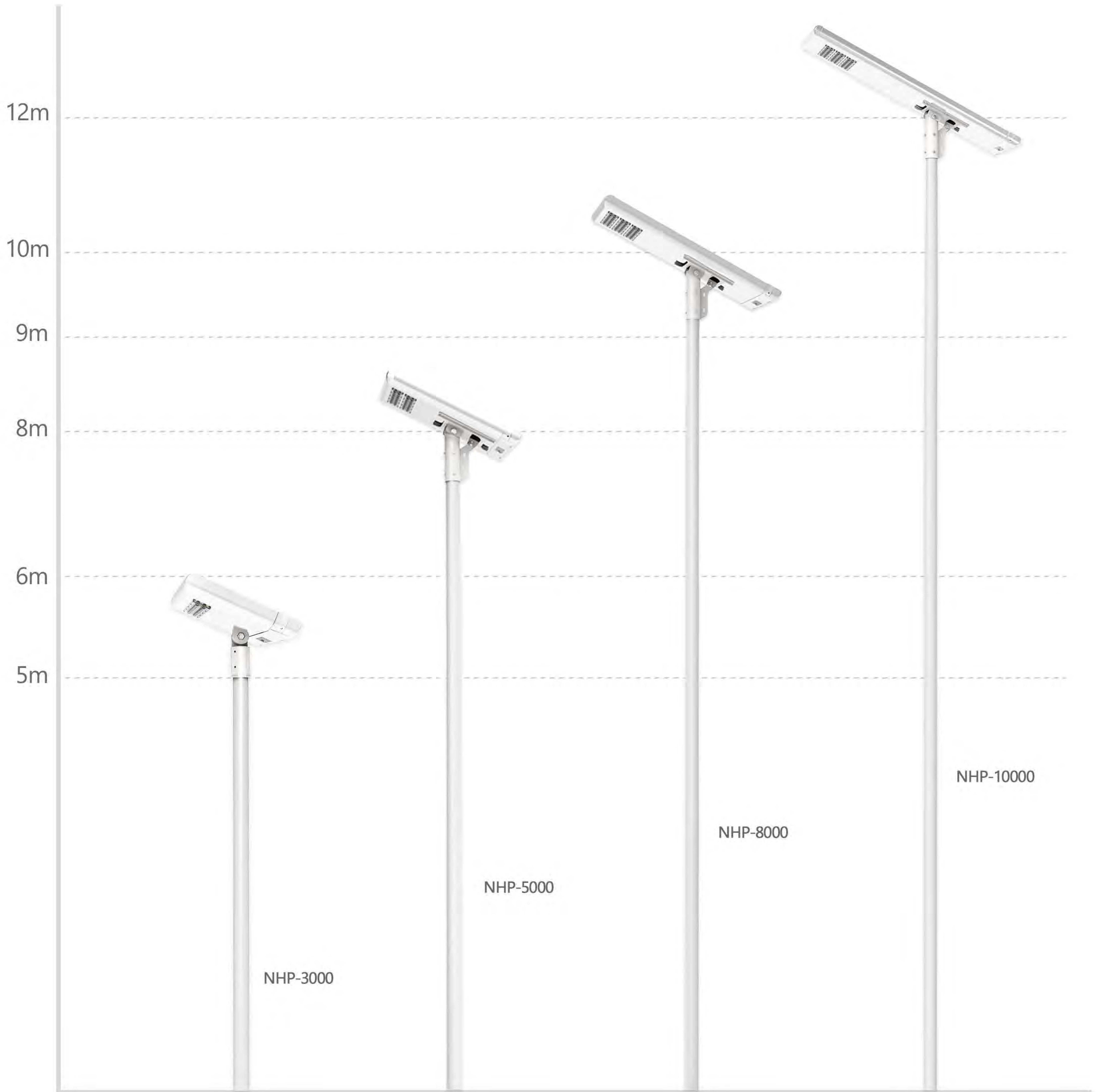

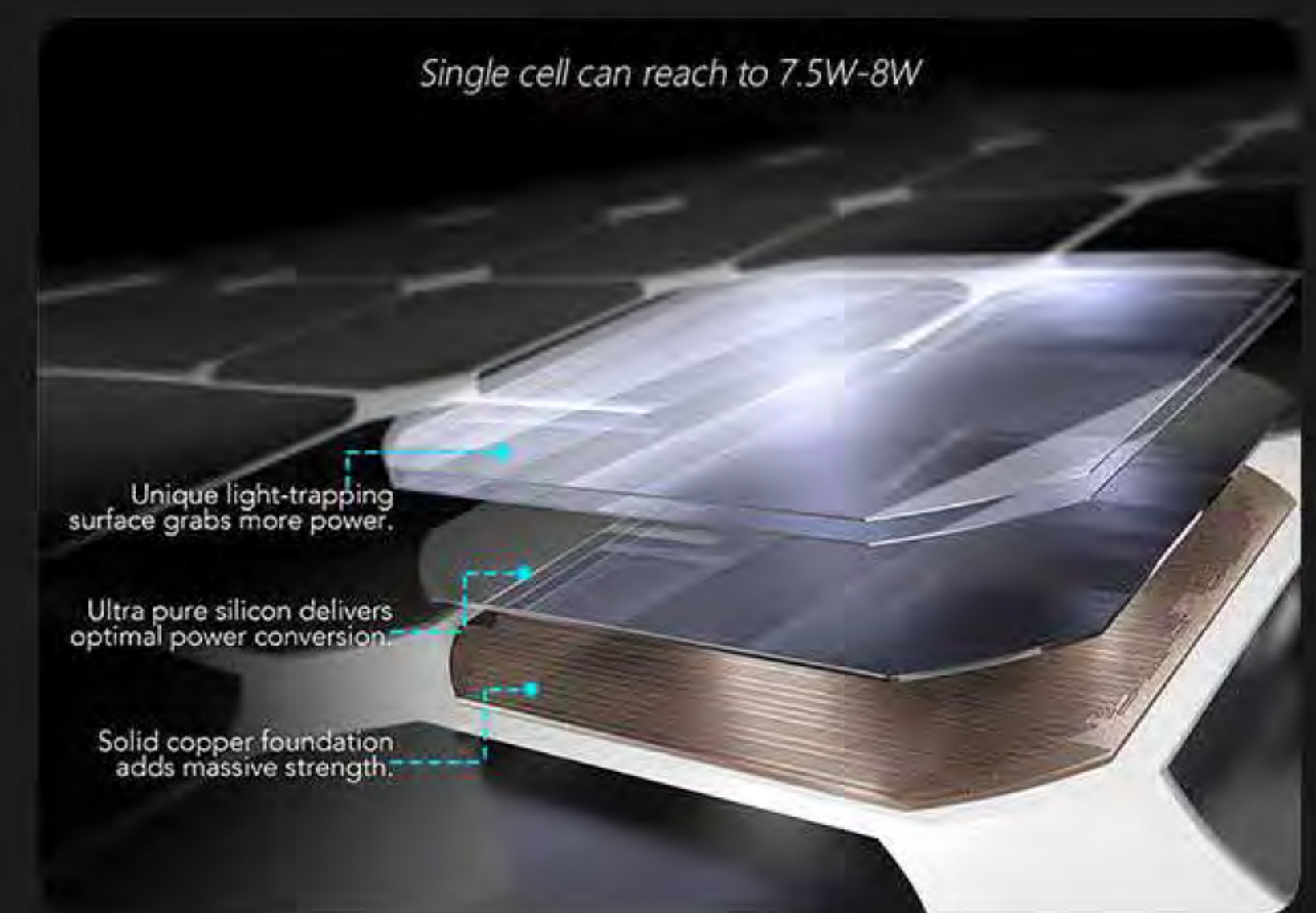

High-efficiency solar panels



Buckle design

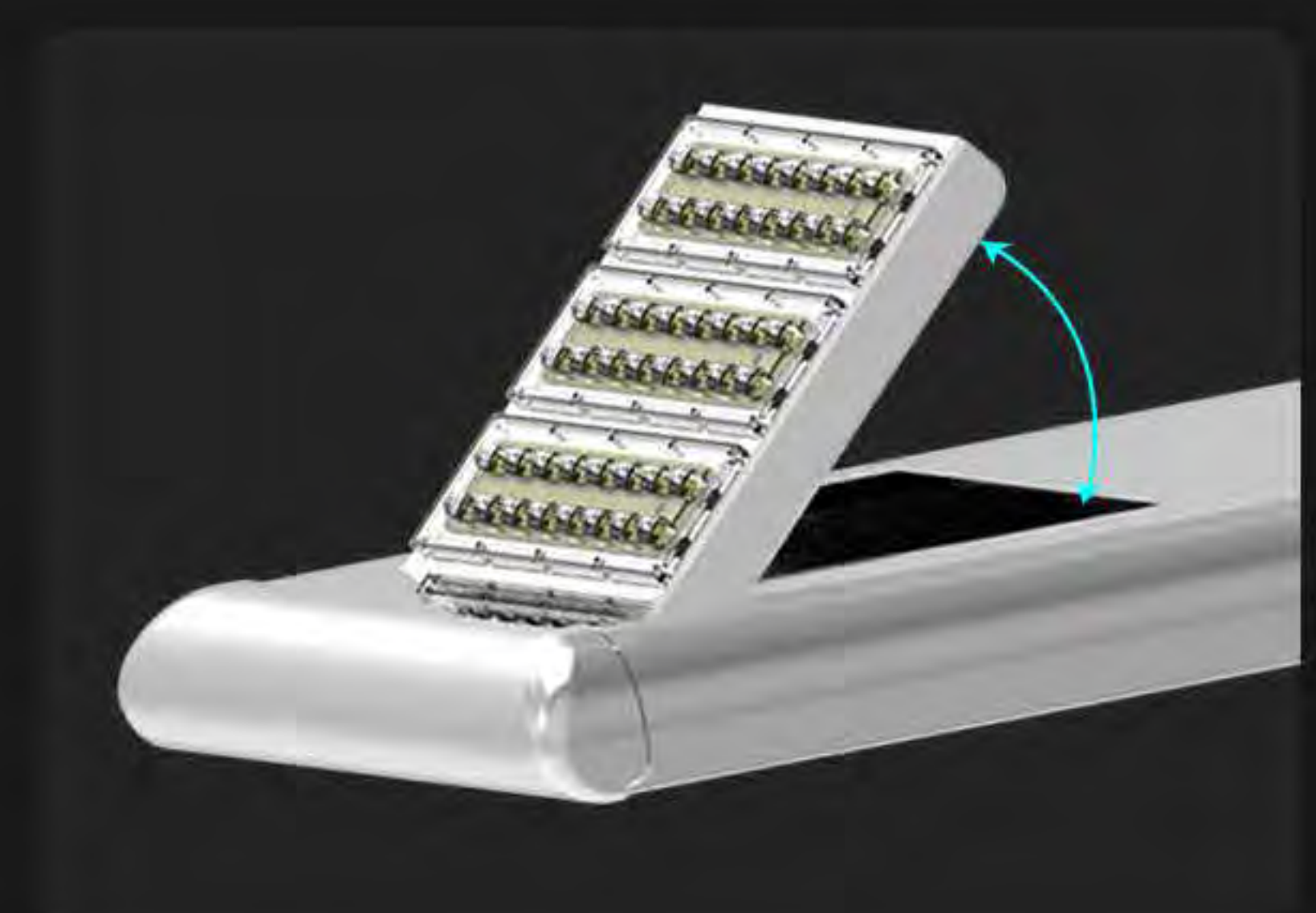

Adjustable led source(Optional)



NOMO



OTHER

Overall Aluminum Heat Dissipation

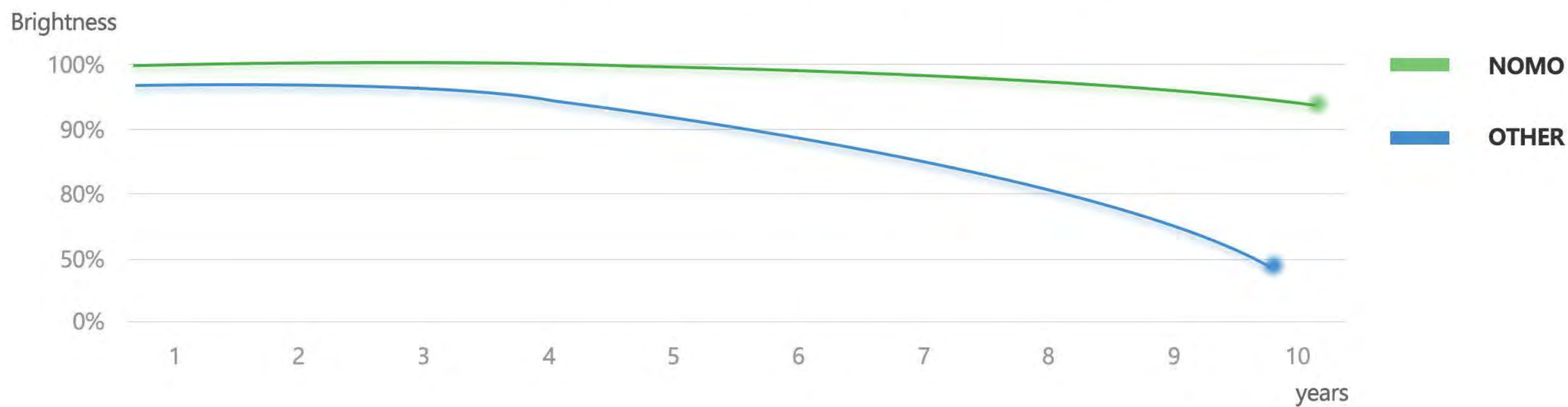

NOMO-100W



OTHER-100W

PV Advantage

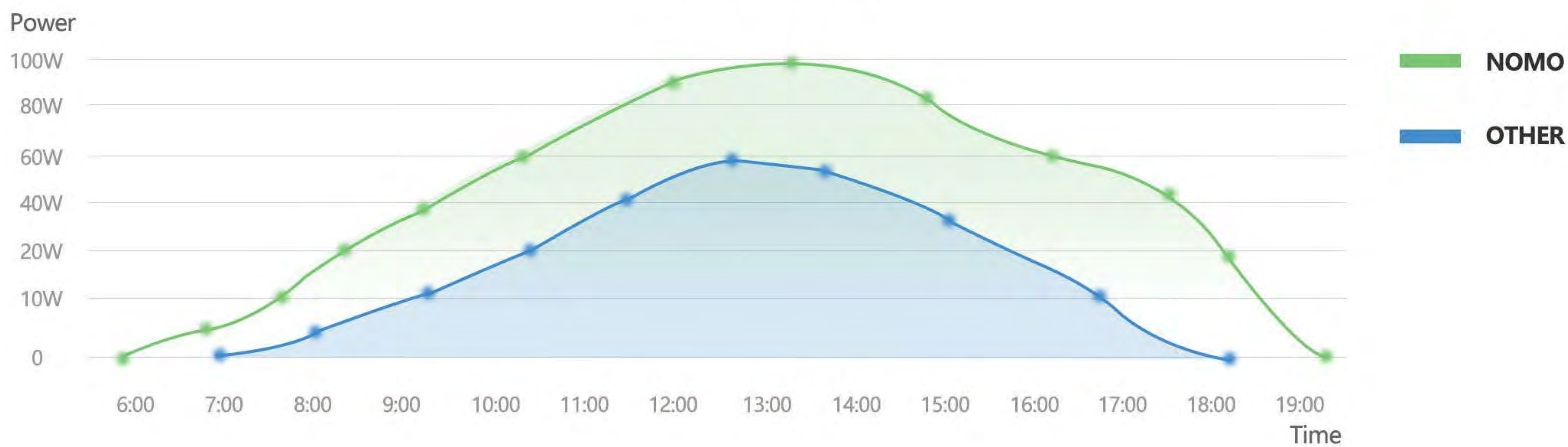

1. Place battery and MPPT controller as per below drawing. Match holes location, then fix it with 2 pcs of M4 lock nuts and 4 pcs of M6 eye nuts.

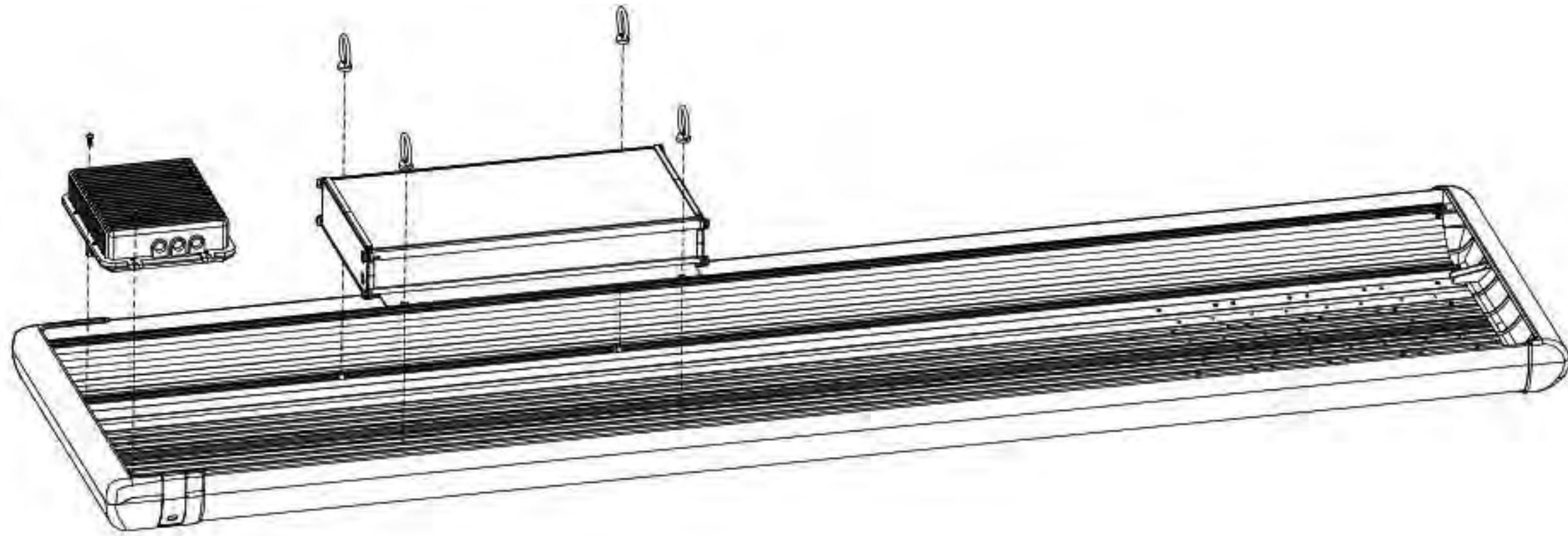

2. Connect the wiring between the LED, solar panel, and battery.

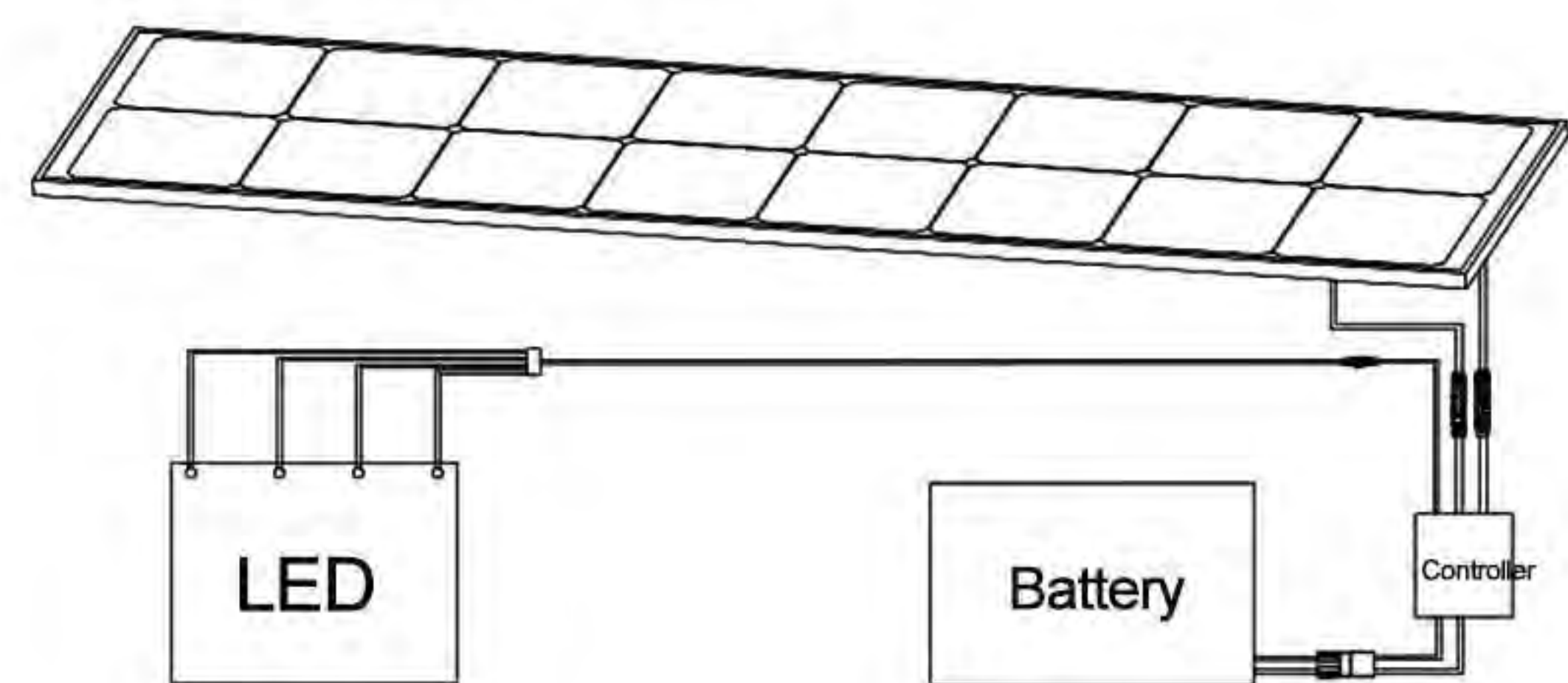

3. Unlock the buckle, place solar panel as per below drawing, buckle up.

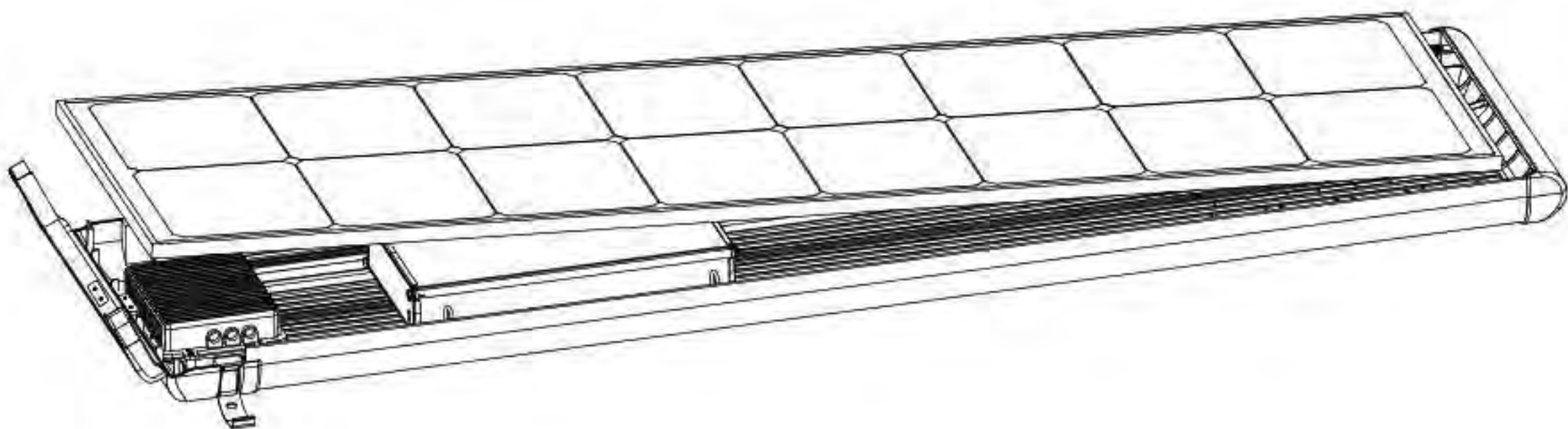

4. Place bracket as per below drawing, and match the location of holes and fix it with screws.

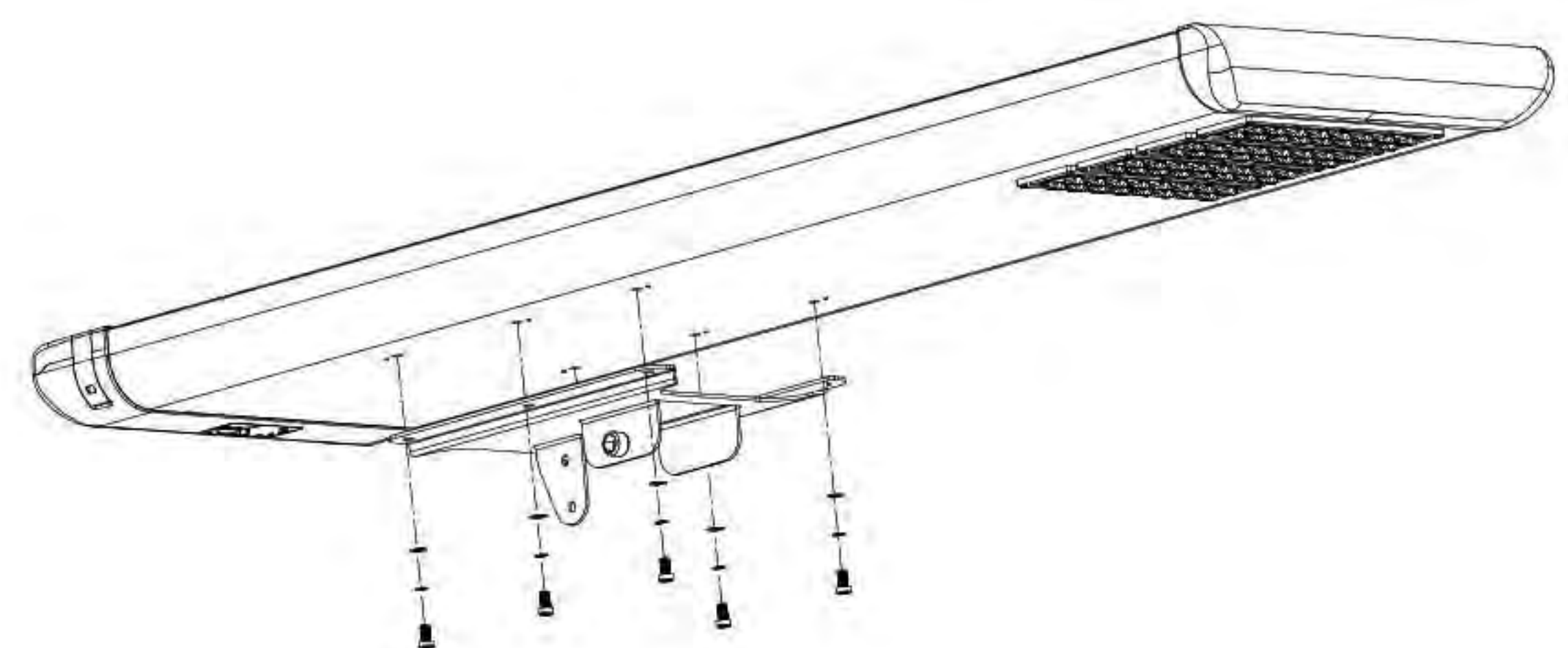

5. Mount street light with bracket on the top of the pole and fix it with screws.

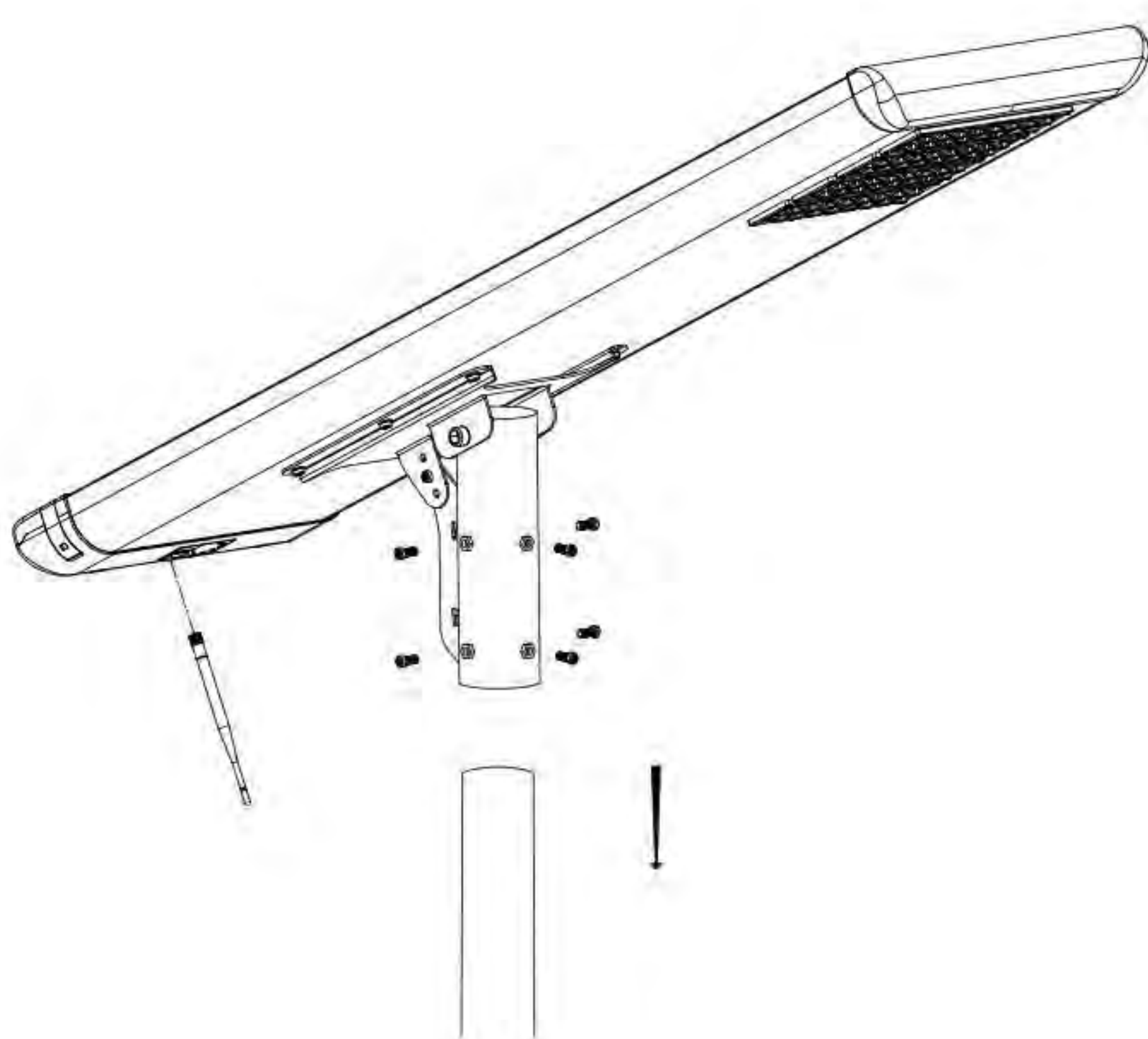

6. The installation of RTU antenna (for product with smart controlling system) Plug the USB into the socket, install the RTU antenna.

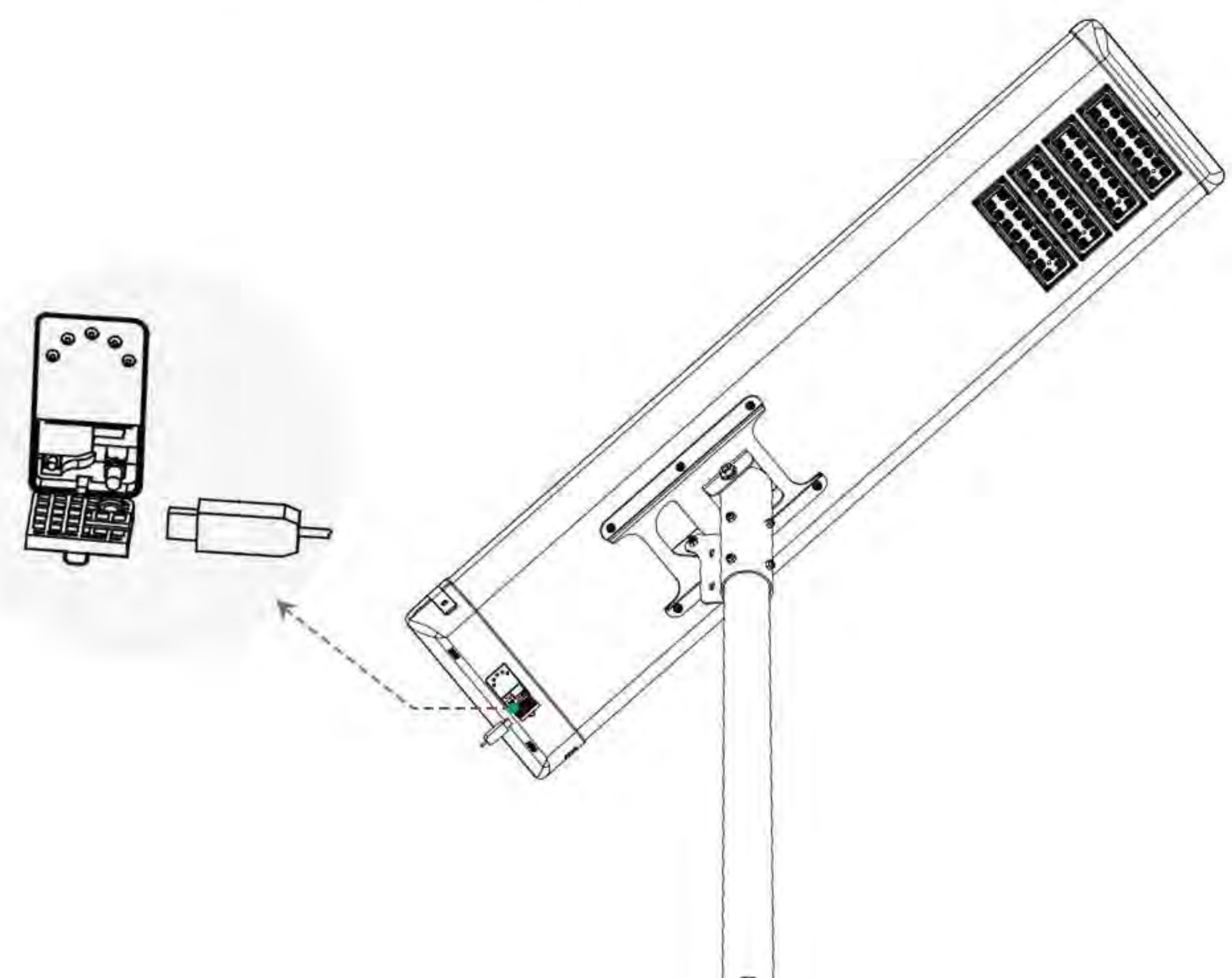

1

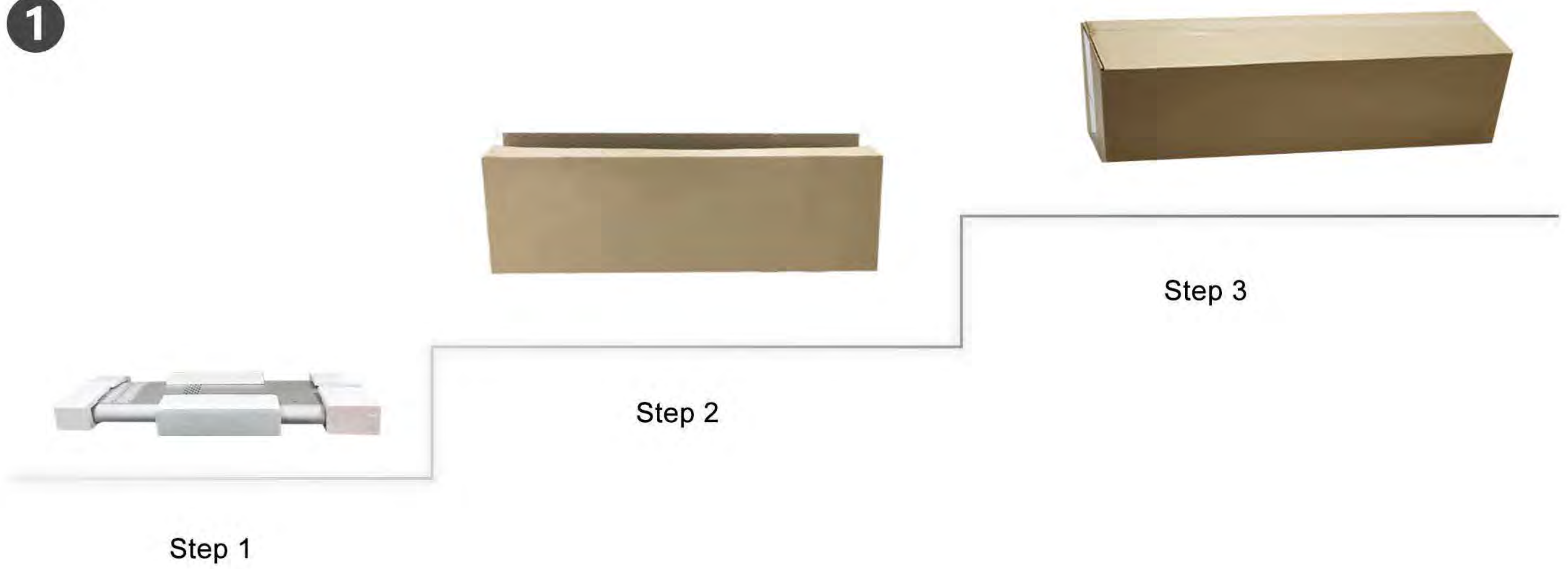

Model NO.	QTY(PCS)	Carton Size(mm)	Net Weight
NHP-3000	1	552*446*150	6kg
NHP-5000	1	887*446*150	7kg
NHP-8000	1	1271*446*150	12.5kg
NHP-10000	1	1645*446*150	18kg

2

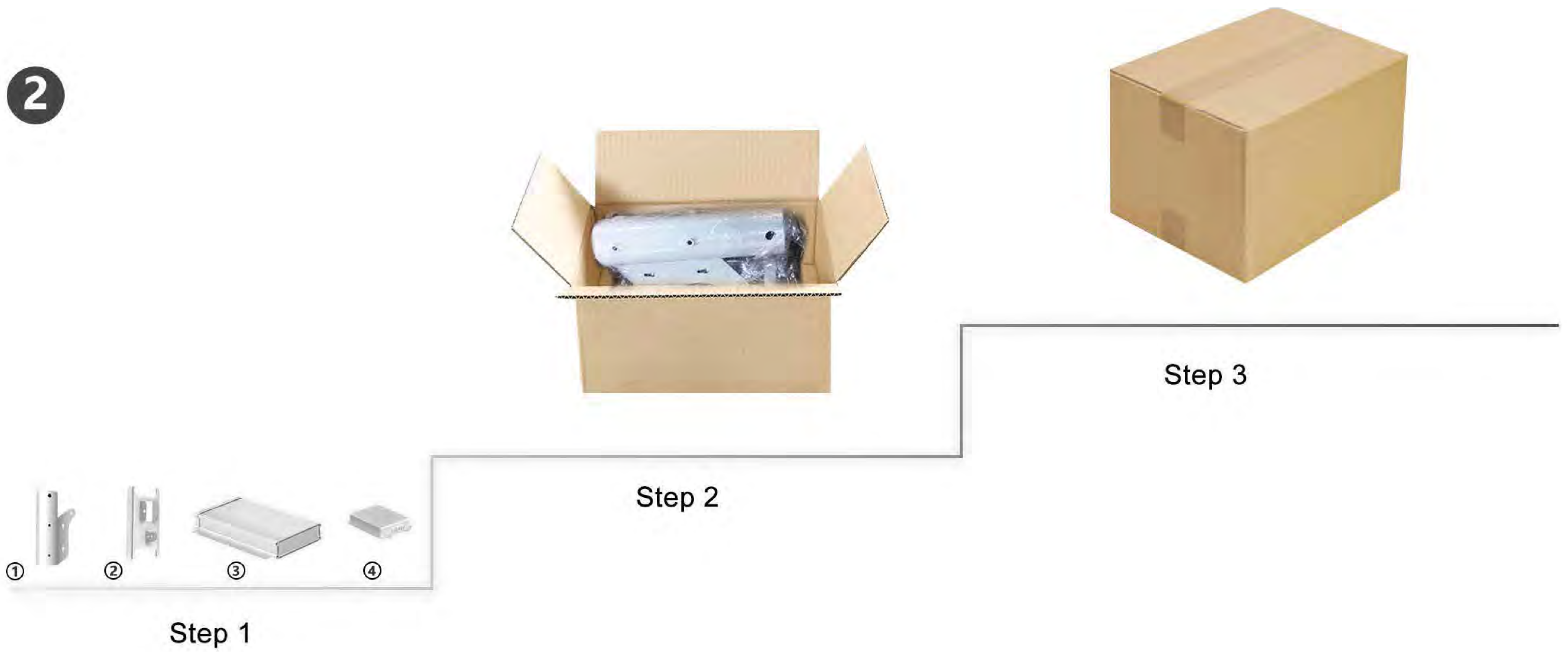

Model NO.	QTY(PCS)	Carton Size(mm)	Net Weight
NHP-3000	4	400*280*200	5.5kg
NHP-5000	4	400*280*200	12kg
NHP-8000	4	400*280*200	12kg
NHP-10000	4	400*280*200	12kg

1

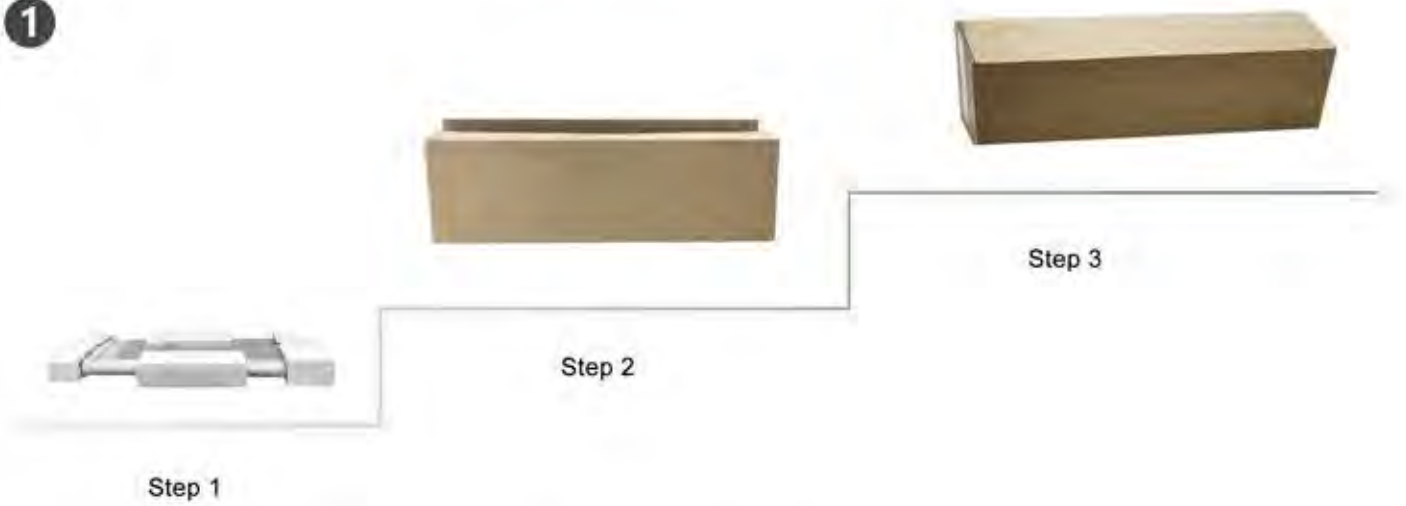

Model NO.	QTY(PCS)	Carton Size(mm)	Net Weight
NHP-3000	1	552*446*150	9.5kg
NHP-5000	1	887*446*150	15kg
NHP-8000	1	1271*446*150	24.5kg
NHP-10000	1	1645*446*150	26kg

2

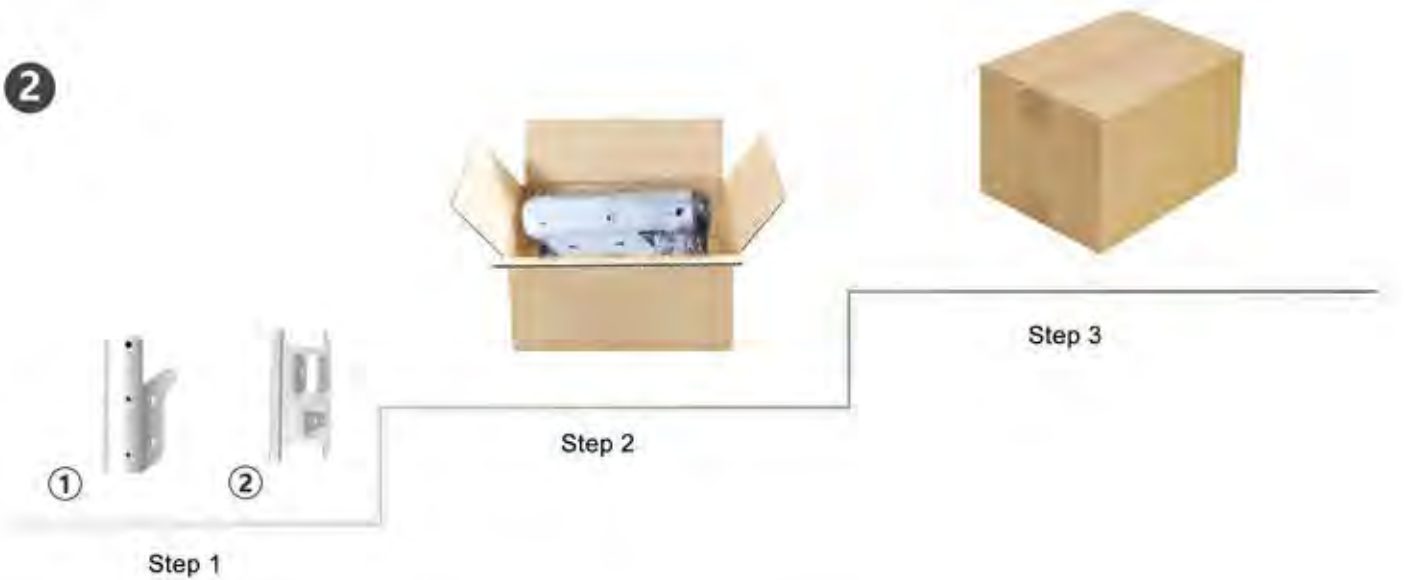

Model NO.	QTY(PCS)	Carton Size(mm)	Net Weight
NHP-3000	8	400*280*200	16kg
NHP-5000	2	380*260*200	8kg
NHP-8000	2	380*260*200	8kg
NHP-10000	2	380*260*200	8kg

VIMALUX

A brighter vision

Solar street lights



www.vimalux.com